

Profili per porte

Rappresentano una soluzione alternativa alle guarnizioni di tenuta, specifica per applicazioni su porte e finestre. Montati sui profili di ante apribili, consentono di realizzare la tenuta ed il contatto tra due superfici laddove, per esigenze di spazio, i classici profili di tenuta per spigoli metallici non riescono a trovare impiego.

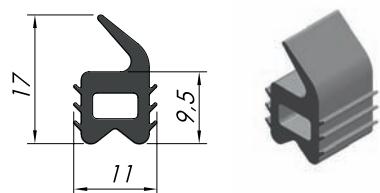

codice	materiale	colore
3B.163.003.001	PVC	nero

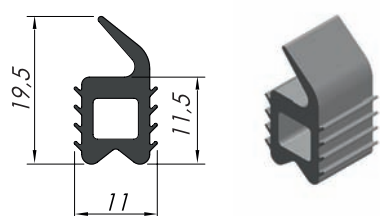

codice	materiale	colore
3B.163.003.002	PVC	nero

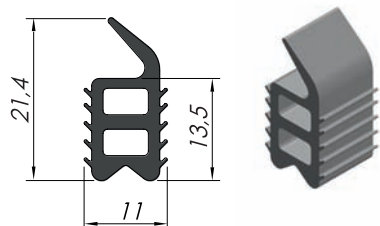

codice	materiale	colore
3B.163.003.003	PVC	nero

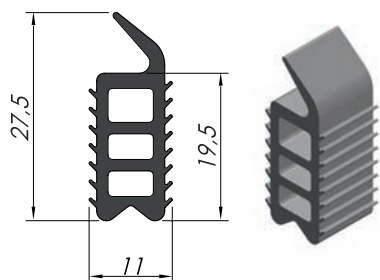

codice	materiale	colore
3B.163.003.004	PVC	nero

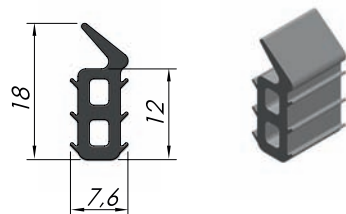

codice	materiale	colore
3B.163.003.005	EPDM	nero

ESEMPIO DI APPLICAZIONE

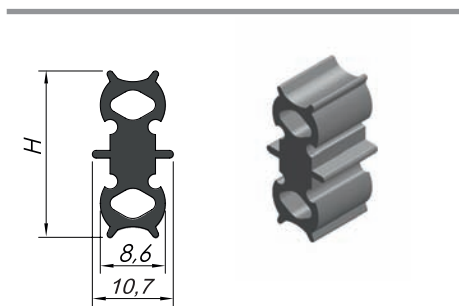
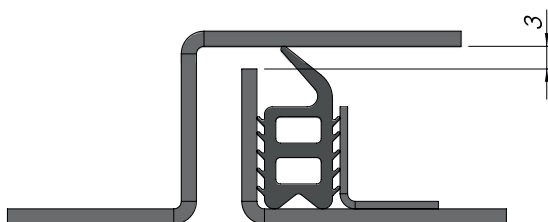

codice	materiale	colore	H [mm]	A [mm]
3B.163.003.006	EPDM	nero	18	16+1
3B.163.003.007	EPDM	nero	20	18+1
3B.163.003.008	EPDM	nero	22	20+1
3B.163.003.009	EPDM	nero	24	22+1
3B.163.003.010	EPDM	nero	26	24+1
3B.163.003.011	EPDM	nero	28	26+1

ESEMPIO DI APPLICAZIONE

Non compresso

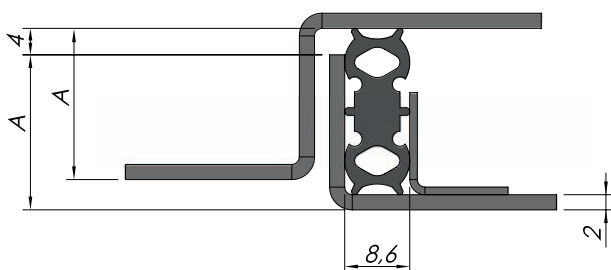

Compresso

