

Autoagganciante con inserto metallico

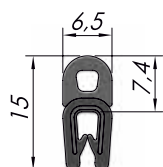

codice	materiale	colore	spessore lamiera [mm]	raggi di curvatura [mm]			
<b>3B.163.002.001</b>	PVC/EPDM	nero	1,0 - 2,0	A = 20	B = 40	C = 10	D = 10

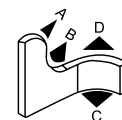
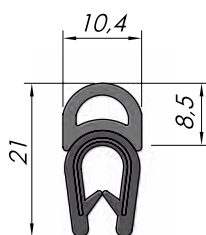

codice	materiale	colore	spessore lamiera [mm]	raggi di curvatura [mm]			
<b>3B.163.002.002</b>	PVC/EPDM	nero	1,0 - 4,0	A = 70	B = 80	C = 15	D = 15

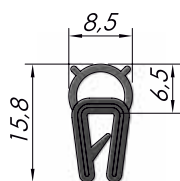
 Modello disponibile  
 certificato EN45545-2

\*Certificato UL

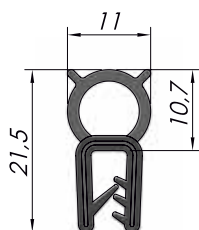

codice	materiale	colore	spessore lamiera [mm]	raggi di curvatura [mm]			
<b>3B.163.002.003</b>	EPDM	nero	1,0 - 2,0	A = 50	B = 60	C = 20	D = 20
<b>3B.163.002.004</b>	EPDM - <b>UL94*</b>	nero	1,0 - 2,0	A = 50	B = 60	C = 20	D = 20

 Modello disponibile  
 certificato EN45545-2

 Modello disponibile  
 in silicone e con cert. FDA

\*Certificato UL



codice	materiale	colore	spessore lamiera [mm]	raggi di curvatura [mm]			
<b>3B.163.002.005</b>	EPDM	nero	1,0 - 3,0	A = 50	B = 180	C = 30	D = 30
<b>3B.163.002.006</b>	NBR	nero	1,0 - 3,0	A = 50	B = 180	C = 30	D = 30
<b>3B.163.002.007</b>	EPDM - <b>UL94*</b>	nero	1,0 - 3,0	A = 50	B = 180	C = 30	D = 30
<b>3B.163.002.008</b>	EPDM	nero	3,0 - 4,5	A = 50	B = 180	C = 30	D = 30

 \*A richiesta modello disponibile in **silicone** colore nero rif. codice **3B.163.002.038**

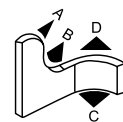

Autoagghiacciante con inserto metallico

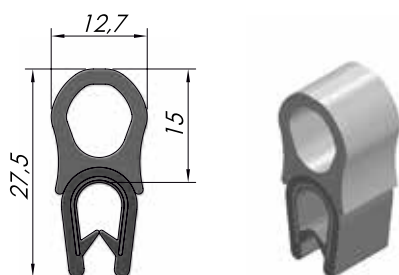

codice	materiale	colore	spessore lamiera [mm]	raggi di curvatura [mm]			
				A	B	C	D
<b>3B.163.002.009</b>	PVC/EPDM	nero	1,0 - 4,0	A = 60	B = 80	C = 20	D = 20

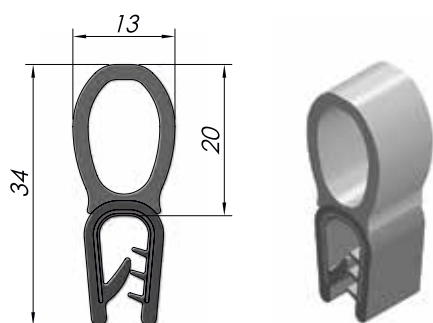

codice	materiale	colore	spessore lamiera [mm]	raggi di curvatura [mm]			
				A	B	C	D
<b>3B.163.002.010</b>	PVC/EPDM	nero	2,0 - 4,0	A = 80	B = 100	C = 20	D = 20

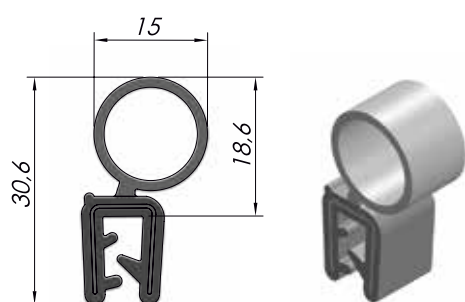

codice	materiale	colore	spessore lamiera [mm]	raggi di curvatura [mm]			
				A	B	C	D
<b>3B.163.002.011</b>	EPDM/spugna	nero	1,0 - 3,0	A = 160	B = 250	C = 200	D = 200

Autoagganciante con inserto metallico

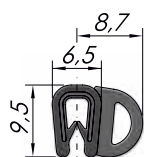
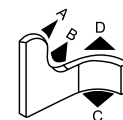

codice	materiale	colore	spessore lamiera [mm]	raggi di curvatura [mm]			
<b>3B.163.002.012</b>	PVC/EPDM	nero	1,0 - 2,0	A = 20	B = 15	C = 30	D = 50

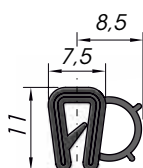

codice	materiale	colore	spessore lamiera [mm]	raggi di curvatura [mm]			
<b>3B.163.002.040</b>	EPDM	nero	1,0 - 2,0	A = 20	B = 50	C = 20	D = 60

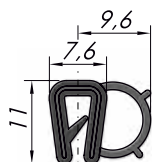
 Modello disponibile  
 certificato EN45545-2

\*Certificato UL

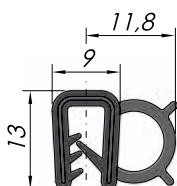

codice	materiale	colore	spessore lamiera [mm]	raggi di curvatura [mm]			
<b>3B.163.002.013</b>	EPDM	nero	1,0 - 2,0	A = 20	B = 50	C = 20	D = 60
<b>3B.163.002.014</b>	EPDM - <b>UL94*</b>	nero	1,0 - 2,0	A = 20	B = 50	C = 20	D = 60

 Modello disponibile  
 certificato EN45545-2

 Modello disponibile  
 in silicone e con cert. FDA

\*Certificato UL



codice	materiale	colore	spessore lamiera [mm]	raggi di curvatura [mm]			
<b>3B.163.002.015</b>	EPDM	nero	1,0 - 3,0	A = 50	B = 20	C = 120	D = 40
<b>3B.163.002.016</b>	EPDM - <b>UL94*</b>	nero	1,0 - 3,0	A = 50	B = 20	C = 120	D = 40
<b>3B.163.002.017</b>	NBR	nero	1,0 - 3,0	A = 50	B = 20	C = 120	D = 40

 \*A richiesta modello disponibile in **silicone** colore nero rif. codice **3B.163.002.048**

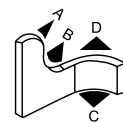

Autoagganciante con inserto metallico

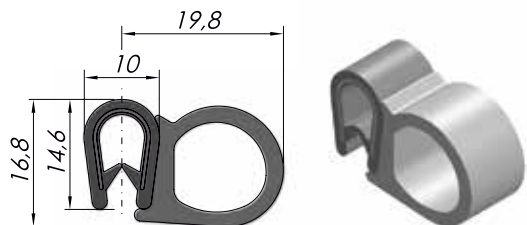

codice	materiale	colore	spessore lamiera [mm]	raggi di curvatura [mm]			
<b>3B.163.002.020</b>	PVC/EPDM	nero	1,0 - 4,0	A = 50	B = 30	C = 100	D = 120

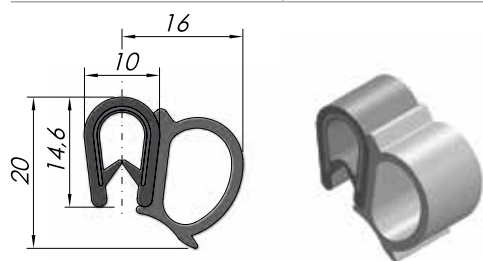

codice	materiale	colore	spessore lamiera [mm]	raggi di curvatura [mm]			
<b>3B.163.002.021</b>	PVC/EPDM	nero	1,0 - 4,0	A = 50	B = 40	C = 100	D = 120

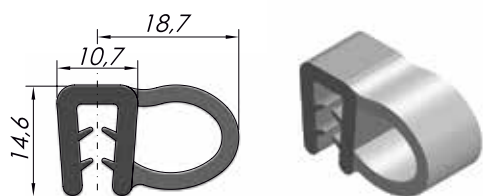

codice	materiale	colore	spessore lamiera [mm]	raggi di curvatura [mm]			
<b>3B.163.002.022</b>	EPDM	nero	1,5 - 3,0	A = 80	B = 60	C = 200	D = 80

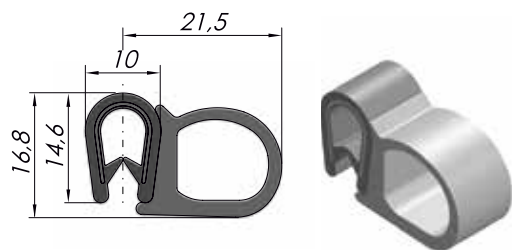

codice	materiale	colore	spessore lamiera [mm]	raggi di curvatura [mm]			
<b>3B.163.002.023</b>	PVC/EPDM	nero	1,0 - 4,0	A = 50	B = 30	C = 100	D = 120

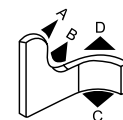

Autoagganciante con inserto metallico

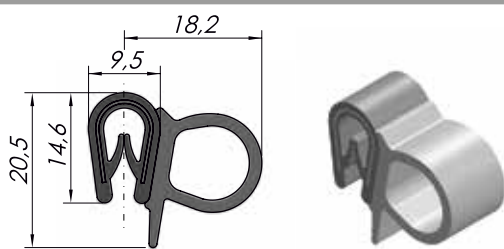

codice	materiale	colore	spessore lamiera [mm]	raggi di curvatura [mm]			
<b>3B.163.002.024</b>	PVC/EPDM	nero	1,0 - 4,0	A = -	B = -	C = -	D = -

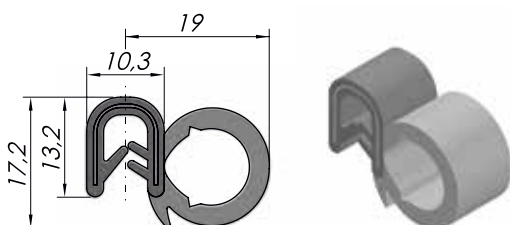

codice	materiale	colore	spessore lamiera [mm]	raggi di curvatura [mm]			
<b>3B.163.002.025</b>	EPDM	nero	1,0 - 3,0	A = -	B = -	C = -	D = -

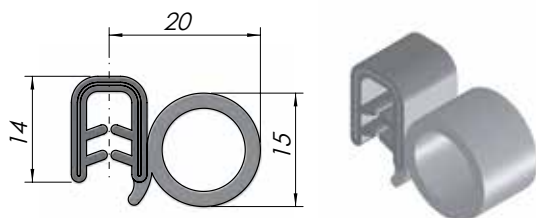

codice	materiale	colore	spessore lamiera [mm]	raggi di curvatura [mm]			
<b>3B.163.002.045</b>	EPDM	nero	1,5 - 4,0	A = 60	B = 70	C = 230	D = 200

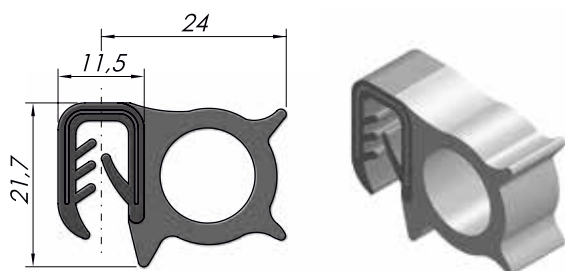

codice	materiale	colore	spessore lamiera [mm]	raggi di curvatura [mm]			
<b>3B.163.002.018</b>	PVC/EPDM	nero	2,5 - 4,0	A = 60	B = 60	C = 120	D = 120
<b>3B.163.002.019</b>	PVC/EPDM	nero	4,0 - 6,0	A = 60	B = 60	C = 120	D = 120

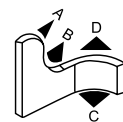

Autoagganciante con inserto metallico

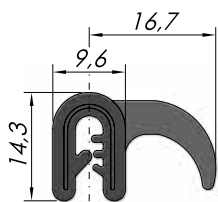

codice	materiale	colore	spessore lamiera [mm]	raggi di curvatura [mm]			
<b>3B.163.002.026</b>	EPDM	nero	1,0 - 2,0	A = 80	B = 40	C = 200	D = 200

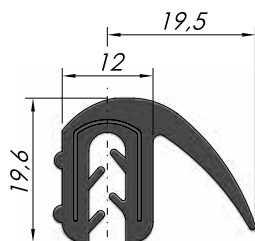

codice	materiale	colore	spessore lamiera [mm]	raggi di curvatura [mm]			
<b>3B.163.002.027</b>	EPDM	nero	1,0 - 2,5	A = 80	B = 120	C = -	D = -

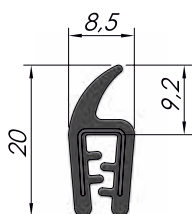

codice	materiale	colore	spessore lamiera [mm]	raggi di curvatura [mm]			
<b>3B.163.002.028</b>	EPDM	nero	1,0 - 2,0	A = 60	B = 200	C = 20	D = 20

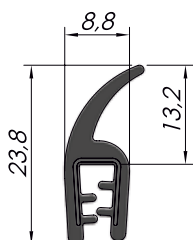

codice	materiale	colore	spessore lamiera [mm]	raggi di curvatura [mm]			
<b>3B.163.002.029</b>	EPDM	nero	1,0 - 2,5	A = 60	B = 250	C = 25	D = 70

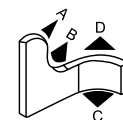

Autoagganciante con inserto metallico

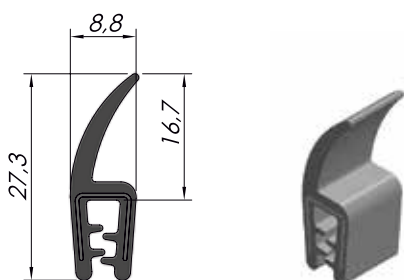

codice	materiale	colore	spessore lamiera [mm]	raggi di curvatura [mm]			
<b>3B.163.002.030</b>	EPDM	nero	1,0 - 3,0	A = 80	B = 250	C = 25	D = 60

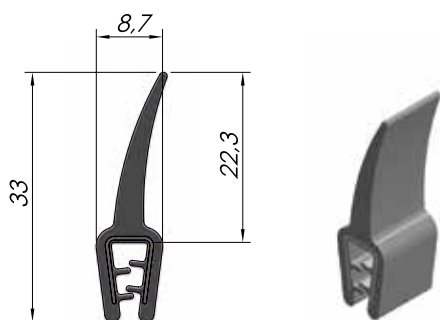

codice	materiale	colore	spessore lamiera [mm]	raggi di curvatura [mm]			
<b>3B.163.002.031</b>	EPDM	nero	1,0 - 2,5	A = 150	B = 250	C = 20	D = 20

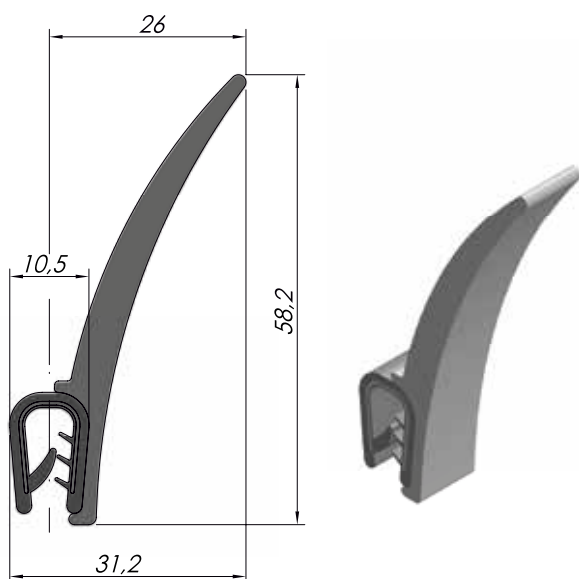

codice	materiale	colore	spessore lamiera [mm]	raggi di curvatura [mm]			
<b>3B.163.002.032</b>	PVC/EPDM	nero	2,0 - 4,0	A = 80	B = -	C = 120	D = 120

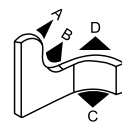

Non autoagganciante senza inserto metallico

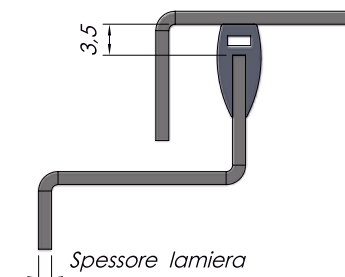
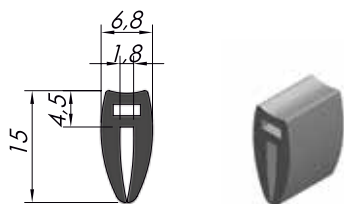

codice	materiale	colore	spessore lamiera [mm]	raggi di curvatura [mm]			
<b>3B.163.002.033</b>	EPDM	nero	1,0 - 3,0	A = 80	B = 250	C = 25	D = 60

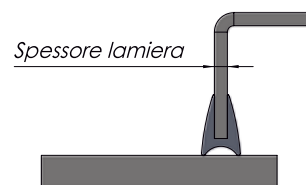
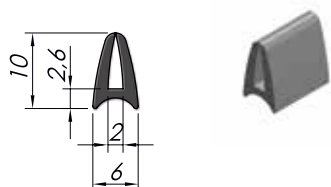

codice	materiale	colore	spessore lamiera [mm]	raggi di curvatura [mm]			
<b>3B.163.002.034</b>	EPDM	nero	1,0 - 3,0	A = 80	B = 250	C = 25	D = 60

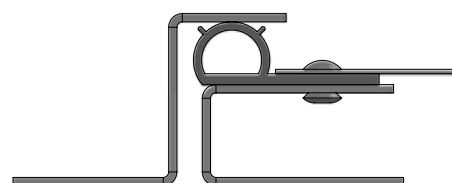
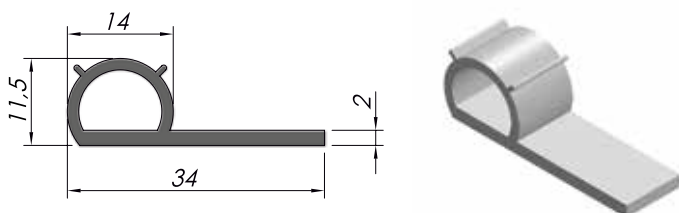

codice	materiale	colore	spessore lamiera [mm]	raggi di curvatura [mm]			
<b>3B.163.002.035</b>	EPDM	nero	1,0 - 3,0	A = 80	B = 250	C = 25	D = 60

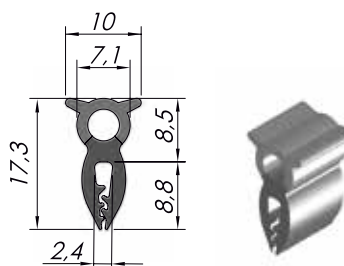

codice	materiale	colore	spessore lamiera [mm]	raggi di curvatura [mm]			
<b>3B.163.002.036</b>	EPDM	nero	1,0 - 1,5	A = -	B = -	C = -	D = -